



Global solutions for flexible packaging

FLEXO PRINTING
OFFSET PRINTING
DIGITAL PRINTING
LAMINATING
SLITTING
DIGITAL SERVICES
AFTER SALES SERVICE

An aerial photograph of a lush green forest. A river winds through the center of the forest, reflecting the sky. Mist or low clouds are visible in the upper right portion of the image, partially obscuring the trees. The overall scene is serene and natural.

**Better packaging.
Better world.**

Reel to reel solutions



Comexi headquarters. Girona. Spain

Comexi, founded in 1954, has accumulated an extensive experience in the manufacture of equipment for the flexible packaging conversion industry. Composed of five different product lines, each one specialized in a different process of conversion, Comexi provides a comprehensive solution adapting the company to the demands of a market in constant development.

The company has two production plants: one in Riudellots de la Selva (Girona, Spain) and another one near the town of Montenegro, in the State of Rio Grande do Sul (Brazil). Besides, has three local offices in Miami (USA) , Moscow (Russia) and Accra (Ghana). Moreover it has representation in more than 100 countries. This commercial network allows us to be close to our customers in order to give an optimal response to their needs.

In recent years, Comexi has added innovation and sustainability to its ability to act globally. These three characteristics, hallmarks of its spirit, have made the company a real leader in machinery for the flexible packaging conversion industry.

Comexi has a specialized team of engineers who can solve the most stringent technological demands providing expertise in the different technologies: printing, lamination, slitting and digital services.

Customer service is essential for Comexi. Because of that, the company has local spare parts stocks and immediate technical assistance with most of its customers, with the aim of avoiding delays caused by manufacturing times, logistics or customs. Moreover, the group regularly implements preventive maintenance measures to help improve its customers' productivity and extend the working life of the machinery.

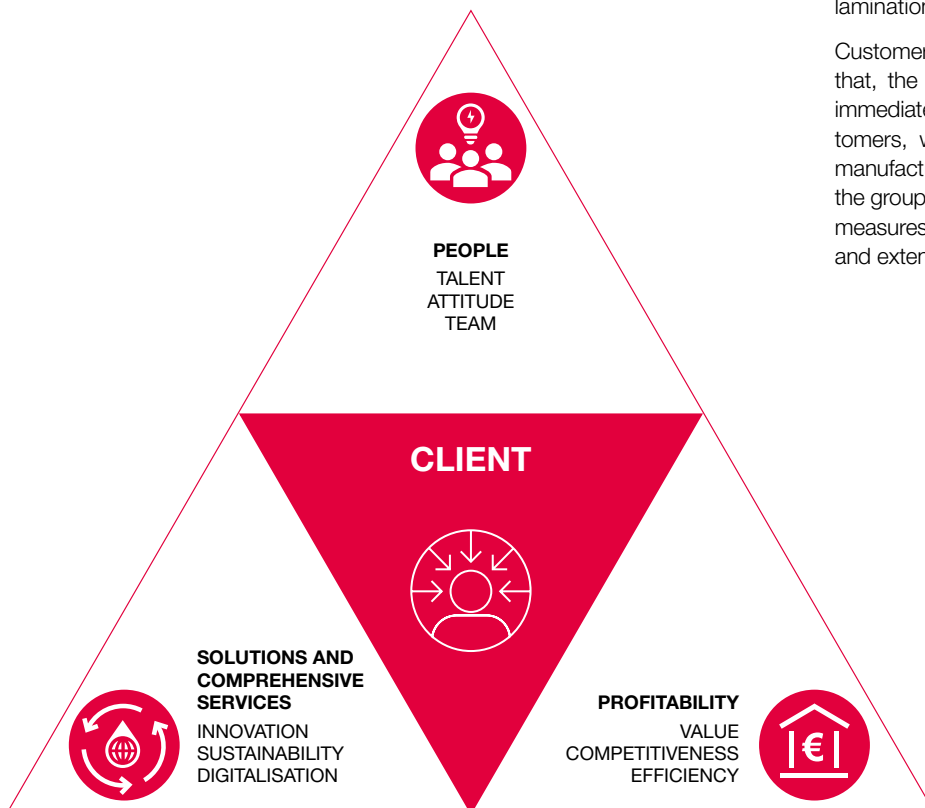



PRODUCTO DIETETICO

MILLAC

Compuesto de leche en polvo desnatada y goma vegetal

1 KG. EQUIVALE A 8 LITROS

1KG. neto

ELABORADO EN ESPAÑA CON EL nº. 301965

COMPRADO EN EIRE POR: PHARMAC PRODUCTS LTD. KILLESHAND

CHURRONA

RED

merguada

ADAPTAN PERFECTAMENTE AUTOSILO

782. 112

Illustration of a woman in a blue dress and a recycling symbol.

Illustration of a cheerleader in a white and black outfit.

ELIHA

WHITE ENRICH

Hols

EN LLEVO PRENDAS...

Souquet, Caballero

Illustration of a man in a suit and bowler hat.

Since 1954

PRINTING

P. 06

Flexo , Offset and Digital

LAMINATION

P.10

Laminating and coating

CLIENT'S
NEEDS

SLITTING

P.12

Slitting and finishing

REEL READY
FOR THE
PACKAGING
PROCESS

CTEC

P. 22

Comexi Technological Center

END OF LINE
SOLUTIONS

P. 14

DIGITAL
SERVICES

P. 16

END PRODUCTS

Food, beverages and other
non food applications

Flexo Printing

With more than 60 years' experience in the sector, we offer the market a high level of technological innovation and a specialised and localised technical service. Flexographic printing is our core business, and with the passage of time, we have become one of the world's leading manufacturers of flexographic presses with a central drum for short, medium and long runs, and which adapt to the market's most demanding requirements.



GeniusTech is a set of technological solutions designed to meet the challenges of flexographic printing. It prioritizes high and easy print quality, sustainable printing and improves equipment use.

COMEXI F1

The F1 machines are defined as excellence in the world of flexography printing with a central drum

With advanced technical solutions, they allow printing at high speeds, thanks to their robustness and drying capacity. The F1 is particularly designed for working with long runs and large repeats.



COMEXI F2 Evolution

Efficiency & printing quality

F2 Evolution is the first member of a new generation of Flexo machines that while maintaining the ergonomics and efficiency of the Comexi F2 presses, incorporates the latest GeniusTech developments to create a range of machines with improved efficiency, printing quality and less dependency on operators.

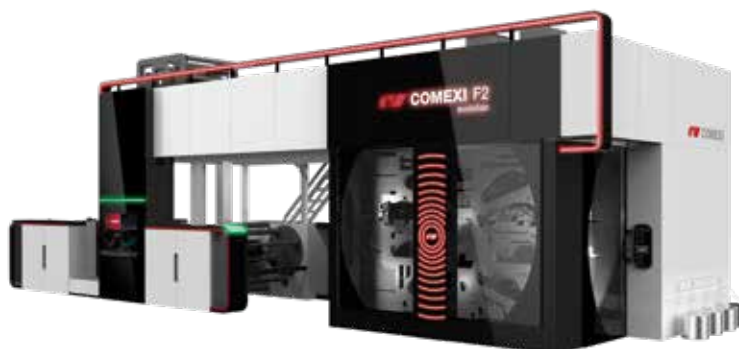

Models	F1	F2 Evolution
Colours	8/10	10
Speed	600 m/min 1 968 ft/min	600 m/min 2 000 ft/min
Max printing width	1 670 mm 65.7 in	1 470 mm 57,8 in
Maximum repeat	1 350 mm 53.1 in	850 mm 33,4 in



COMEXI F2 MB / MC

The perfect press for your market needs

The Comexi F2MB/MC flexographic press has been designed to satisfy the print needs of medium runs in the flexible packaging sector for the retail and wholesale channel.

The Comexi F2MB/MC shares the patented FLEXOEfficiency concepts of ergonomics and accessibility, as well as the performance and robustness of the rest of the F2 range. F2MC has more powerful drying specially indicated in case of very long runs.



COMEXI F2 MP

Top quality and high performance

The Comexi F2 MP has been designed to meet the printing needs of the longest jobs in the flexible packaging sector. Among all the GeniusTech solutions, maximum focus has been placed on those that contribute to easily achieve the highest print quality at high speed, such as GeniusRun for antibouncing printing, GeniusDry for the highest drying performance at high speed, and GeniusDoctoring for trouble-free ink transfer.

Sustainability has also been taken into account in the design of the Comexi F2 MP, so alongside the various energy-efficient solutions there is a dedicated version for water-based inks, or a hybrid press for water-based inks, Electron Beam inks or solvent-based inks.

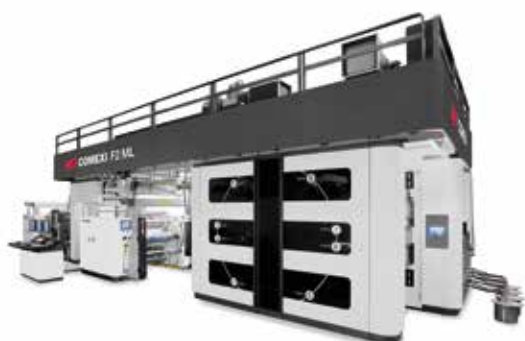

COMEXI F2 ML

Think big

The Comexi F2 ML printer is the ideal solution for the demanding polyethylene market. An excellent machine from the point of view of profitability, designed to get the best quality at high speeds with large repeats.

An impeccable flexographic printing press that stands out for its high degree of versatility maintaining the ergonomics and usability features of the F2 range.



COMEXI F4

The most effective solution for flexographic printing in short and medium runs. The Comexi F4 machine is the reference in this market segment.

The Comexi F4 has been the first to embody the patented FLEXOEfficiency concepts of ergonomics and accessibility, as well as performance and robustness, which are also characteristics of the whole Comexi F2 machine range. It is the perfect solution thanks to its dimensions that facilitate any form of handling during the printing process

Models	F2 MB / MC	F2 MP	F2 ML	F4
Colours	8/10	8	8/10	8
Speed	400 m/min 1 312,3 ft/min	500 m/min 1 640,4 ft/min	500 m/min 1 640,4 ft/min	300 m/min 984,2 ft/min
Max printing width	1 270 mm 50 in	1 470 mm 57,8 in	1 470 mm 57,8 in	870 mm 34,2 in
Maximum repeat	800 mm 31,5 in	850 mm 33,4 in	1 160 mm 45,4 in	600 mm 23,6 in

Offset Printing

The offset printing technology has evolved with proven performance in flexible packaging and labels.

Comexi has a solution for its most demanding clients: offset printing with a central drum. This innovative system adapts to the time to market, reducing printing costs and reducing the environmental impact thanks to the EB solvent-free inks.

We are at the forefront of this technology due to its new press including color closed loop and other new features.



Sustainability

Solvent free technology, with curing ElectronBeam (EB) inks and coatings. Consumes less ink, less energy and is capable to print wide range of substrates even the thinnest films.



High quality printing

Highest definition, printing high quality pictures, smooth gradations and it is the best option for extended gamut process.



Fast time to market

Pre-press designs can be automatically converted. The plates are imaged in a CTP in few minutes, a complete set of plates can be made in less than 20 minutes.



Competitive costs

CI uses lithographic plates. New designs can be introduced without expensive costs. In the same run, it's possible to group designs, printing multiple SKU, saving time and waste!



High efficiency

Offset CI can print in a wide width at high speed, it is equipped with robotic change of sleeves, providing maximum productivity and fast changeover.

COMEXI CI Evolution

The key to expanding the flexible packaging and labeling markets

Comexi offers the definitive printing solution for the most demanding customers: CI offset printing technology. It is ideal for short and medium runs and perfectly meets the stringent needs for fast, high-quality printing. This technology is completely solvent-free, making it the best environmental solution, as it reduces the number of layers and the carbon footprint, while offering the most competitive operating costs. The Offset CI is not only the best option to expand the market, but presents new solutions in recyclable flexible packaging as well.



Models

CI Evolution

Colours	8 (7 Offset EB + 1 Flexo EB)
Speed	300 m/min 984 ft/min
Max printing width	1 050 mm 41 in
Maximum repeat dimensions	455 m 17,9 in
Maximum repeat dimensions	930 mm 36,6 in

Digital Printing

Digital printing press for variable data printing

Digiflex is a digital variable data print press that offers you the best digital printing of variable Datamatrix, QR codes, barcodes, text and other numbering and marking applications. With a very high printing speed, high quality results and the highest level of performance and production.



All in one solution

Single solution that includes the integration of: curing process, tension control, printing register, video inspection system, corona treatment and spliced sensor. The all in one solution allows independent, efficient production and faster time to market.



Efficiency

Reduced set up time: its digital printing, high speed up to 220 m/min, less material waste and improvement in the lead time.



UV Low Migration Inks

Thanks to the use of this kind of inks you get: printing suitable for food applications, excellent results in the quality tests: tape test, ethanol test and scratch test, possibility to print on both sides: no treatment needed and possibility to print on already printed material.



Printing Quality

Resolution: up to 1200 x 1200 dpi, size: minimum code size 8 x 8, print consistency and registration consistency.

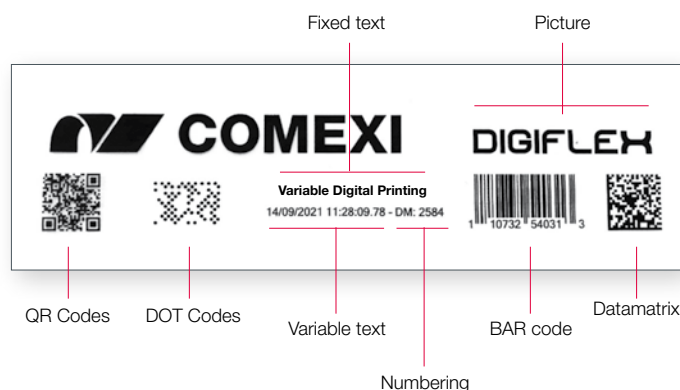

COMEXI Digiflex

Models

Digiflex

Reel width	1 320 mm
Max. Printing Width	1 250 mm
Number of lines	From 1 to 12 lines De 1 a 12 líneas
Max. Line Printing Width	40,6 mm
Speed	Up to 220 m/min - Grade B Hasta 220 m/min - Grado B
Inks	UV Low Migration - Black UV baja migración - negra
Resolution	Up to 1 200 x 1 200 dpi hasta 1200 x 1200 dpi
Material thickness	From 12 to 200 µ De 12 a 200 µ
Dimensions	6,5 m x 3,7 m x 2,2 m

Lamination

With the aim of being the main global supplier for the flexible packaging industry, Comexi has positioned itself as one of the leading firms in laminators and coating solutions. It has achieved the highest quality standards in laminating with solventless adhesives as well as water-based adhesives or solvent, thanks to its constant commitment to state-of-the-art technologies. Furthermore, its continuing innovation in the finishing sector has allowed holographic solutions that provide attractive designs and copy-proof attributes.



COMEXI SL2 MB

Simple solutions for complex laminating jobs.



COMEXI L20000

Water-based laminator for digital short runs.



COMEXI SL2 Evolution

The Comexi SL2 Evolution has been designed to comply with the concepts of productivity and ease of operation. Its exclusive applicator head design, consisting of complete motorisation and the use of metering sleeves, along with the option of incorporating automatic change turrets and its extremely intuitive touch environment make it the best option for solventless lamination.

Models	SL2 MB	SL2 Evolution	L20000
Speed	400 / 450 m/min 1312.3 - 1476.3 ft/min	500 m/min 1640.4 ft/min	150 m/min 492.1 ft/min
Max. web width	1330 mm 52.4 in	930 / 1330 / 1530 mm 36.6 / 52.4 / 60.2 in	920 mm 36.2 in
Adhesive	SL	SL	WB
Aut. reel change	-	RW + UW	-



COMEXI ML2 Evolution

The ML2 Evolution can work with all kind of adhesives and coatings: solvent-based, waterbased, wax or solvent-less. It can also perform wide range of in-register applications like like Coldseal, ink or varnishes. To that end, it has a series of easily interchangeable technological trolleys to satisfy all these demands. It also has a completely modular drying tunnel which greatly helps in performing a larger number of applications. The winding section can also be configured according to different requirements.



COMEXI ML1 MC

Conceived for the most demanding applications and thanks to its extreme versatility and modularity it covers any application in the market: Coatings, Solvent Free, water or solvent based lamination among many others. Designed for reducing downtimes to the minimum expression, the Comexi ML1 MC has proved to be the most profitable laminator of the market for high demands.

COMEXI FUTURA

Holographic machine designed for finishing solutions.



Models	ML2 Evolution	ML1 MC	FUTURA
Speed	450 m/min 1 476,4 ft/min	450 m/min 1 476,4 ft/min	450 m/min 1 476,4 ft/min
Max. web width	930 / 1 330 / 1 530 mm 36,6 / 52,4 / 60,2 in	1 330 / 1 530 mm 52,4 / 60,2 in	1 330 mm 52,4 in
Adhesive	SB / SL / WB / UV / WAX	SB / SL / WB / UV	UV / SL
Aut. reel change	RW + UW	RW + UW2	-

Slitting

Comexi provides the most sophisticated slitting and rewinding machines, making a permanent stand for research and innovation. It offers high value solutions, like the innovative Laser system, which give the client an additional benefit of making life easier for the packaging end users. Micro-perforation, QR codes, easy-open are applied to the flexible packaging sector thanks to the firm's loyal client-focused orientation.



COMEXI S2 DS

2 shaft rewinder slitter with a compact design and ergonomic.



COMEXI S1 DS

Fast, versatile slitter that allows working with large diameter reels.



COMEXI S1 MS

Mono-shaft slitter designed for non stretchable materials and big output reels.

Models	S2 DS	S1 DS			S1 MS
		V6	V8	V10 & (HD)	
Speed	500m/min 1640.4 ft/min	600 m/min 1968.5 ft/min	800 m/min 2624.7 ft/min	1000 m/min (850mm) – 800m/min (1000mm) 3280.8 ft/min (2.8 ft) 2624.7 ft/min (3.3ft)	600 m/min 1968.5 ft/min
Material width	900 to 1400 mm 3 to 4.6 ft	900 to 1700 mm 3 to 5.6 ft	900 to 1700 mm 3 to 5.6 ft	1400 to 2100 mm (2100=600mts/min)	1400 to 2100 mm 4.6 to 6.9 ft
Parent roll diameter & Weight	1000 mm (1T) 3.3 ft	1000 mm (1T) 3.3 ft	1300 (2T) / 1500 (3T) mm 4.3 (2T) / 4.9 (3T) ft	1300 (2T) / 1500 (3T) mm 4.3 (2T) / 4.9 (3T) ft	1300 (2T) / 1500 (3T) mm 4.3 (2T) / 4.9 (3T) ft
Web path	Integrate/Compact	Underneath	Overhead	Overhead	Underneath
Slitting width	40 mm 0.13 ft	40 mm 0.13 ft	20 mm 0.07 ft	20 mm 0.07 ft	50 mm rigid or semirigid & 300mm elastic material
Rewinding system	Duplex	Duplex	Duplex	Duplex	Monoshaft
Finished roll diameter	610 mm 2 ft	800 mm 2.6 ft	800 mm 2.6 ft	850 – 1000(HD) mm 2.8 – 3.3 (HD) ft	1300 mm 4.3 ft
Acceleration ramps	60 sec	30 sec	20 sec	30 sec	60 sec



COMEXI S2 DT

Double turret rewinder slitter with high productivity, compact design and energy efficient.



COMEXI S1 DT

High performance double turret rewinder slitter.



COMEXI S1 MT

Single turret slitter for non stretchable materials and big output reels.

Models	S2 DT	S1 DT		S1 MT
		V6	V8	
Speed	500m/min 1640.4 ft/min	600 m/min 1968.5 ft/min	800 m/min 2624.7 ft/min	600 m/min 1968.5 ft/min
Material width	900 to 1400 mm 3 to 4.6 ft	900 to 1700 mm 3 to 5.6 ft	900 to 1700 mm 3 to 5.6 ft	1400 to 2100 mm 4.6 to 6.9 ft
Parent roll diameter & Weight	1000 mm (1T) 3.3 ft	1000 mm (1T) 3.3 ft	1300 (2T) / 1500 (3T) mm 4.3 (2T) / 4.9 (3T) ft	1300 (2T) / 1500 (3T) mm 4.3 (2T) / 4.9 (3T) ft
Web path	Integrate/Compact	Underneath	Overhead	Underneath
Slitting width	40 mm 0.13 ft	40 mm 0.13 ft	20 mm 0.07 ft	50 mm rigid or semirigid & 300mm elastic material
Rewinding system	Turret	Turret	Turret	Turret
Finished roll diameter	610 mm 2 ft	610 mm 2 ft	610 mm 2 ft	1000 mm 3.3 ft
Acceleration ramps	60 sec	30 sec	20 sec	60 sec
Turret rotation	35 sec	30 sec	20 sec	35 sec

End of line solutions

Comexi offers 3 different added value processes in line associated to the slitter rewinder machine.

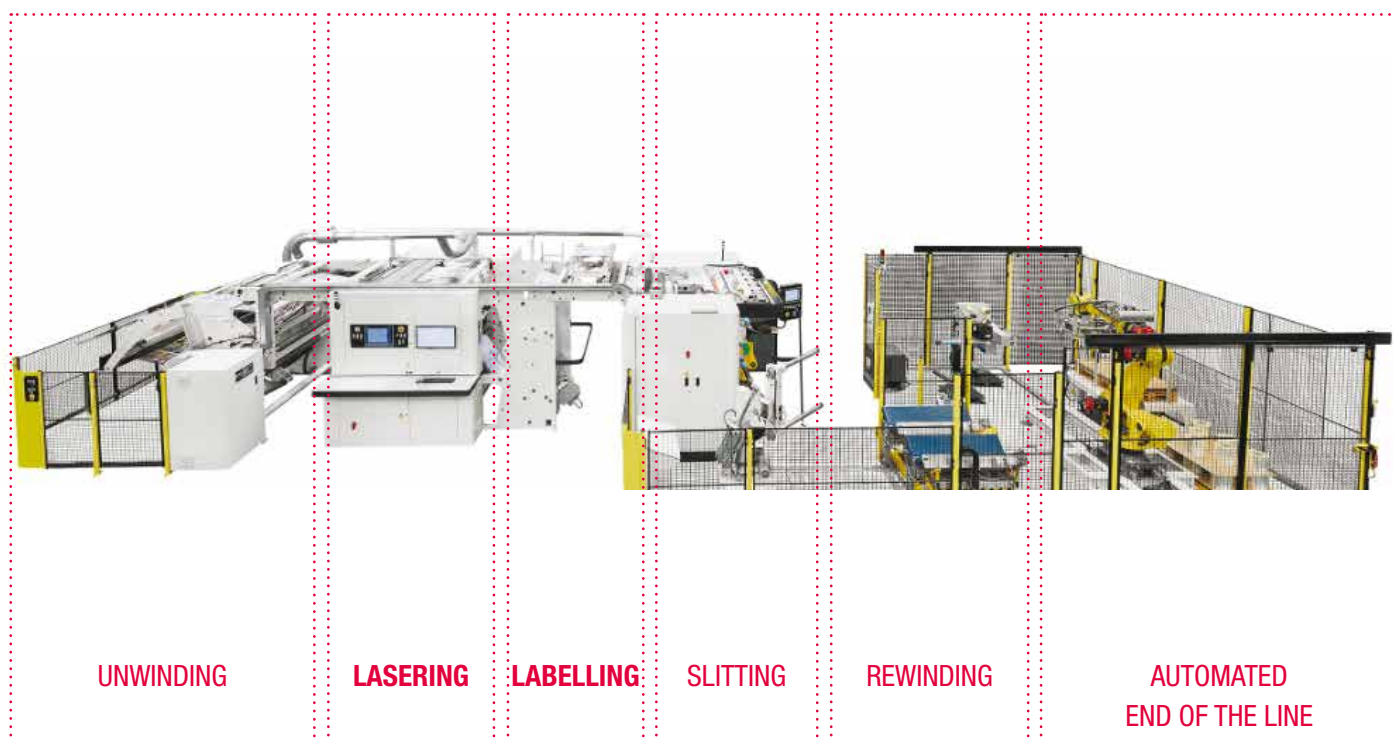



COMEXI REEL HANDLING

Comexi offers the possibility to automate all the operations that occur after rewinding such as transport, labelling, weighing, bagging, palletizing getting significant benefits:

- Improved labour management
- Safe environment (while ensuring the production workflow)
- Increased productivity (with high quality)
- Improved internal logistics
- Return on investment (in less than 1 year)



COMEXI LABELLING

- Integrate an Inline label module to add adhesive labels.
- Create resealable opening



COMEXI LASER

- Comexi laser is an inline laser solution integrated to the slitter
- Customization and differentiation
- Control, precision and speed
- Wide gama of applications in one single equipment:
 - Micro perforation
 - Macro perforation
 - Windows
 - Security systems
 - Easy-open
 - Alphanumeric and bar codes
 - Pre-cut adhesive labels

Digital Services









Digital service platform

Flexible packaging is probably one of the most dynamic industrial sectors with constant innovation focusing on customer satisfaction, traceability and environment protection.

The personalization and the state-of-the-art of the packaging drive a continuous optimization of the resources and processes due to the increasing number of SKUs, shorter runs, higher quality demands, traceability, as well as developing new packaging with an extended shelf life, easy to use and recyclability.

The sole way to adapt and succeed in this new environment is to have total control over the entire value chain system and all related information. Bringing a holistic approach to the whole converting processes will enhance a new era of continuous improvement, unique with agile decision.

Technical specifications

 Track Performance 24/7	Comexi Cloud is working for you 24/7, track your plant work everyday at anytime.
 Private Data Acquisition	The data is saved in private data centers accessible to our client only, guaranteeing its security.
 Automatic Data Acquisition	Plug & Play: Focus on work only, data acquisition is completely automatic.
 Zero Coding	No Deployment.
 Simple Data Processing	On Cloud Service.
 Manage and control	See your plant worldwide.
 Multiplatform	Web deployment.

COMEXI CLOUD



Monitoring plan
Real-time information

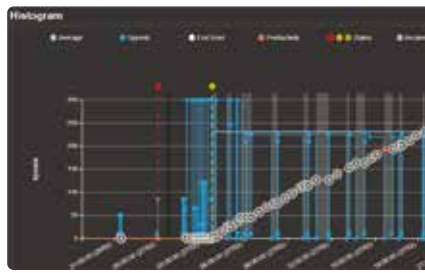

Production control
Historic and process set up parameters



Performance indicators
Machine – Production order – Time

Production Analytics

The fastest and easiest way to analyse production, understand data and processes, as well as know the job cost of the printing and converting process. This data gives the customer relevant production information to make the most appropriate decisions.

Job Costing

Through the data automatically taken by the machine from consumption of energy, inks and consumables, the module provides the total cost per m2 printed during a specific period of time.

Comexi Ordering Online service (Be Coolable)

Make your orders with the new e-commerce platform. An easy and free of charge service allowing for quick identification, 3D and electrical diagrams, faster speed up order process, security, all with 24/7 service.

Maintenance Assistant

Comexi takes care of the machine maintenance offering task reporting.

Technical Docs

Manuals and instructions are always available and updated.

Data Export

Comexi Cloud Data Export allows you to access to all machine's data from any applications such as ERP, MES and MCS according to your needs. This data is private and secure, ready to be analyzed easily.



After sales services



The most innovative solutions for your company

The Comexi Service team knows that time is money and therefore it works to provide the best and fastest responses for its clients.

Comexi has a team of more than 40 people dedicated to offering the best and fastest service to its clients. As well as providing the fastest and the most innovative solutions, its aims is to make the most of its equipment for as long as possible.



Spare parts service Ordering Online

Comexi attends to the needs of all product line as quickly as possible. The service team is prepared to process clients' order and offer the best terms of delivery for both parts issued from Girona or any of the local warehouses distributed around the world.

From now on, it is possible to easily place your spare parts orders through Comexi's e-commerce service. Simplify spare parts purchases and do it quicker, easier and safer with 24/7 online service, available on the digital service platform: Comexi Cloud.



Technical support Service

Comexi has a team of technical specialists that give equipment remote support in order to reduce possible incidents in the machinery and optimize production. This consultancy, detection and problem resolution service is free-of-charge within office timetable. Better coverage in after-sales support and assistance by having a direct line of communication for resolving emergencies. Additionally, Comexi provides 24/7 support service during the whole year.



Operational maintenance

The annual operational maintenance program is a service created to optimize machine productivity by reducing non-programmed downtimes, optimizing the spare parts needed in the warehouse and reducing repair and maintenance expenses.

The program includes 2 interventions per year with the aim of check the preventive maintenance program of the machine, detect any problem that may affect the machine's performance and correct parts subject to wear and tear.

After sales services

Remote support Plus with smart glasses

Our latest innovative solution based on smart glasses, smartphones and tablets which allows sharing information between either customer maintenance Engineers or Comexi's field Engineers and support departments. It consists on the remote assistance through smart glasses to solve complex tasks providing real-time information. It definitely helps to reduce machine downtimes and improves efficiency at all levels.



Periodic assistance program (PAP)

Developed to carry out a continuous assessment of the condition of the equipment and ensure its production and appropriate maintenance.

This program consist on doing one-day regular in-situ visits aimed to solve incidents and queries, setting machine setpoints, getting spare parts recommendations and exchanging relevant information with production and maintenance staff.



Comexi supply center

**Smart cabinet 24/7, monitored from Comexi ERP
Avoid running out of any consumable part**

- Access control through ID-cards with incorporated RFID-Chips
- Regular capture of stocked items through COMEXI SUPPLY CENTER
- Capture of RFID-labels on product packaging
- Stock control in realtime through COMEXI CLOUD SERVICE
- Automatic replenishment of missing parts through SAP

Follow-up audits

Designed for short interventions, without affecting machine production and intended to revise and advise clients on various aspects related to their machines. This consists on checking the running status of maintenance tasks recommended by Comexi, checking that the machine processes are run correctly, checking the spare parts warehouse that are critical for machine operability and analyzing possible machine improvements.

Machine retrofitting & upgrades

Comexi offers retrofitting for starting up machines in order to prevent the risk of obsolescence and also to prolong the equipment's useful life. Some of the available measures are updating machines fitted with electronic equipment at risk of becoming obsolete and updating accessories such as web guides, treaters and videos, among others.

At the same time, there are different upgrading measures offered in order to improve equipment productivity, reduce equipment operating and maintenance costs and add new functions. Moreover, a wide variety of upgrades in flexographic machine are available too.

* Check our more special bespoke services and 2nd hand machine terms at www.comexi.com

Comexi offers different technical Service Packages that can be chosen based on customer's personal needs and requirements. These programs have been designed to provide top-quality service through the newest and most advanced tools and technologies.



Expanding Knowledge



Comexi CTec Girona

The Comexi CTec is an institution of reference in the flexible packaging industry, as a knowledge engine. In keeping with the philosophy of the founder of Comexi, Mr. Manel Xifra Boada and as a tribute to his principles of providing assistance to clients and the sector, the group has put its faith in the creation of this technological centre as an independent company.

With a view to consolidating the competitiveness of our clients, the Comexi CTec works in four main areas:



Training and academic activities

We are committed to training and our aim is to become the driving force of knowledge within the flexible packaging sector, through technical seminars, custom-made courses and training programs in various languages related to different printing and converting processes.



Demo & trial center

We have our own latest generation machinery park with an area of 2200m2 and 11 machines in Girona and 900m2 and 5 machines in Miami.



Innovation and R&D services

We want to be a meeting point for suppliers, clients and external research areas with the aim of developing potential technical collaborations.



Consultancy services

We work alongside converting companies and brand owners to offer them an optimal advice in their manufacturing processes as well as new technological and business developments.

Miami
Demo Center

Brasil
Demo Center



Girona
Demo Center

Better packaging. Better world.



Comexi Group Industries S.A.U.

Polígon Industrial de Girona
Avinguda Mas Pins, 135
E-17457 Riudellots de la Selva.
Girona. Spain

Tel.: +34 972 477 744

Fax: +34 972 477 384

comexi@comexi.com

Comexi do Brasil, LTDA.

Estrada Buarque de Macedo, 4499

Bairro Faxinal

Montenegro / RS

CEP 95780-000-Brasil

Tel.: +55 51 3649-8500

Fax: +55 51 3649-8515

brasil@comexi.com

Comexi North America, INC.

1623 N.W. 84th Ave., Miami

Florida 33126

Ph.: +1 (786) 408-6140

Fax: +1 (786) 408-6150

northamerica@comexi.com



The information in this brochure may be subject to modifications.

